

HARO



Laminate Floor

The natural wood look for your floor

Laminate floors, easy to clean and as beautiful as wood

Naturally beautiful flooring

- 04** Our Values
- 14** Range Overview
- 16** Wear Class
- 18** Moisture Protection
- 19** Surface Treatment

28 TRITTY 100



20 TRITTY 200 Aqua



38 TRITTY 90



44 Special Edition NKL 31



- 50** HARO Room Visualizer
- 52** Top Connect Installation
- 53** Incredibly Quiet
- 54** HARO Accessories
- 58** Certification



**Millions of people
walk on HARO
Floors every day.
Find out why!**

Wood has been our passion since 1866.



We have been working with wood for over 150 years. As Germany's leading flooring manufacturer, we produce naturally beautiful floors with passion and care. With our special expertise in the area of wood, we bring the best of two worlds together in our Laminate Floors: natural styles that are almost indistinguishable from wood and a technical construction that makes the floors particularly hard-wearing and especially easy to clean and maintain. Even in the 5th generation, we take our responsibility as a family company seriously and are committed to society, the environment, and people – with respect and appreciation.





Appreciated worldwide. Made in Germany.



To ensure that you enjoy your HARO Floor for many years to come, we process and finish only the highest quality materials. Our floors have proven their worth millions of times and are installed all over the world. But they are not made just anywhere – they are made here in Rosenheim. Investing in a high-quality HARO Floor provides long-term value and benefits.

Quality for the highest standards.



Do you know what makes HARO Laminate Floors so special?

It is the fact that behind the natural appearance of the styles in the look of oak, maple and other quality woods, there are also convincing inner values: wood as the main component makes our Laminate Floors a sustainable, healthy choice for all living areas. The elaborate construction ensures durability and robustness.

The insulation underlay creates a 'forest floor' effect and reduces indoor sound. Quality you can hear and feel.





We learn from the best: Nature.



The moment you see and touch a HARO Floor, you immediately feel the natural beauty. Naturally, the same holds true for our Laminate Floors. Our inspiration for this is always nature – the changing light and colours, the shapes and textures. Natural beauty feels right in every room, every single day. Simply perfect.

For us, sustainability is more than just a word.



Wood is HARO's most important raw material. It is an essential component of our floors, and our decades of expertise in wood also ensure exceptionally natural surfaces for our laminate floors. The regrowth of wood depends on a healthy environment. We take our environmental responsibilities seriously, with a focus on long-term thinking and carefully considered action. Naturally, this includes the careful use of all resources, and the potential for our products to be recycled.



Perfect throughout the home

HARO Laminate Floors are ideal for all rooms. Whether it is surface aesthetics, installation height, maximum weight capacity or the application area – with four different series, we meet all needs.

TRITTY 200 Aqua – The Hard-wearing One

Thanks to the high level of use and its excellent resistance to abrasion, this floor is ideally suited for more heavily used living areas such as hallways and kitchens, and even for commercial applications. The extra moisture protection also makes TRITTY 200 Aqua the right choice for the bathroom.

Level of use 23/33

TRITTY 100 The Tough One

For residential applications with high traffic and commercial applications with medium traffic

Level of use 23/32

TRITTY 90 The Trendy One

For residential applications with high traffic and commercial applications with medium traffic

Level of use 23/32

Special edition NKL 31 The Starter Model

For residential applications with high traffic and commercial applications with low traffic

Level of use 23/31

Formats:



Gran Via 4V
Dimensions: 243 x 2200 mm
8 mm thick

Plank 1-Strip 4V
Dimensions: 193 x 1282 mm
8 mm thick



Gran Via 4V
Dimensions: 243 x 2200 mm
8 mm thick

Plank 1-Strip 4V
Dimensions: 193 x 1282 mm
8 mm thick



Plank 1-Strip 4V
Dimensions: 193 x 1282 mm
7 mm thick

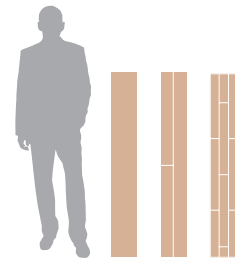

Plank 1-Strip, 2-Strip, 3-Strip
Dimensions: 193 x 1282 mm
7 mm thick

Campus 4V
Dimensions: 243 x 1282 mm
8 mm thick





1



2



3



4



5

1

3-Strip – Dynamic

- Three parallel strips create a vibrant look
- Classic Styles
- Gives large areas a clear structure
- Dimensions: 193 x 1282 mm

2

2-Strip – Markant

- Two parallel strips per board element
- Gives rooms a distinctive character
- Dimensions: 193 x 1282 mm

3

Plank 1-Strip – Classic

- Almost indistinguishable from real parquet
- Modern-classic board aesthetics
- Dimensions: 193 x 1282 mm

4

Campus 4V – Trendy

- Classic board length with a generous width
- Gives even vibrant styles a harmonious look across the whole surface
- Dimensions: 243 x 1282 mm

5

Gran Via 4V – Gigantic

- Gives rooms a more spacious appearance
- The board has an authentic character thanks to the bevelled edges on all four sides
- Dimensions: 243 x 2200 mm



Do you need more information?
Get online product advice here!

Laminate Floors: the floor for any occasion

Whatever your requirements, at HARO you will find a laminate floor that perfectly suits your taste – always in a quality that meets the highest standards. Here you can see at a glance which series best suits your requirements.

TRITTY 200 Aqua

For high-traffic and residential and commercial applications



TRITTY 100

For residential applications with high traffic and commercial applications with medium traffic



TRITTY 90

For residential applications with high traffic and commercial applications with medium traffic



Special edition NKL 31

For residential applications with high traffic and commercial applications with low traffic



RESIDENTIAL
APPLICATIONS

Bedroom	Recommended	Recommended	Recommended	Recommended
Children's room	Recommended	Recommended	Recommended	Recommended
Dining room	Recommended	Recommended	Recommended	Recommended
Living room	Recommended	Recommended	Recommended	Recommended
Hallway	Recommended	Recommended	Recommended	Possible
Kitchen	Recommended	Recommended	Recommended	Possible

COMMERCIAL
APPLICATIONS

Office	Recommended	Recommended	Recommended	
Hotel room	Recommended	Recommended	Recommended	
Conference room	Recommended	Recommended	Recommended	
Doctor's practice	Recommended	Possible	Possible	
Reception area	Recommended			
Showroom	Recommended			

Recommended Possible

A waterproof solution

HARO Laminate Floors are suitable for any room – even if it gets damp. Thanks to the aquaTec system, you can rest assured that they will always stay in shape. Additional safety is provided by the new TRITTY 200 Aqua Series, which is even resistant to standing tap water for up to 24 hours.



aquaTec – double moisture protection

Their well-balanced multilayer construction ensures that HARO Laminate Floors remain stable at all times. And they will always stay in good shape. This is ensured by the special aquaTec system, which combines the moisture-control aquaResist HDF coreboard with a specially impregnated surface protection layer (overlay and decorative layer).



TRITTY 200 Aqua – even better moisture protection

With the aquaReject moisture-control coreboard, TRITTY 200 Aqua is optimally protected against moisture and is also approved for installation in damp rooms (Wo-1 in accordance with DIN 18534), such as domestic bathrooms or kitchens. Due to its special impregnation and the highest degree of resistance against swelling, TRITTY 200 Aqua can withstand standing tap water for up to 24 hours. Moisture test based on test method ISO/DIS 4760:2021.

Surfaces that stand out

The surface treatment protects and refines the laminate floor. To give the individual appearance of each board its final touch, HARO's designers first choose the style. Only then do they decide which type of finish best suits the look of the floorboard.



Textured matt

Similar to real wood grain. The matt appearance underlines the natural look.

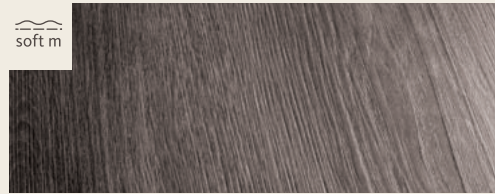

Soft matt

Noticeably velvety-soft and naturally matt with a slight gloss effect in the texture.

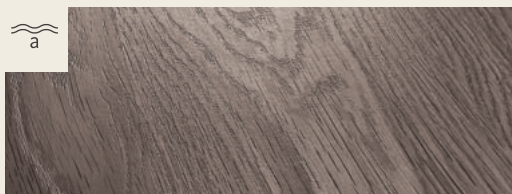

Authentic

The texture and style are virtually indistinguishable from real wood. The gloss level emphasises the character and natural look of the wood reproduction.

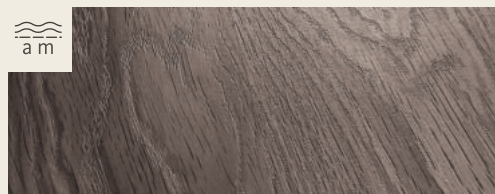

Authentic matt

The texture and style are virtually indistinguishable from real wood. The surface has a natural oil character and Plank 1-Strip also has a slight gloss effect in the pores.



Authentic soft

The texture and style are virtually indistinguishable from real wood. The surface feels velvety and soft.



Bevelled edges on the long and short sides

To create an even more vivid impression, the edges on the long sides and ends are bevelled.

TRITTY 200 Aqua

The hard-wearing laminate floor with extra moisture protection



- Suitable for damp rooms
- Double moisture protection due to aquaTec system
- With the level of use 33, the highest abrasion class AC 6 and a thickness of 8 mm, it is particularly hard-wearing and abrasion-resistant
- Incredibly fast and easy to install thanks to TopConnect
- Available with Silent Pro (luxury insulation underlay) or Silent CT (the world's quietest laminate floor)
- Suitable for use with underfloor heating and cooling

Formats



Gran Via 4V

Dimensions: 243 x 2200 mm

Plank 1-Strip 4V

Dimensions: 193 x 1282 mm

HARO Laminate Floor
TRITTY 200 Aqua
Plank 1-Strip 4V
Oak Flavia Nature
(wood reproduction)





*HARO Laminate Floor
TRITTY 200 Aqua
Plank 1-Strip 4V
Oak Flavia Grey authentic
(wood reproduction)*



*HARO Laminate Floor
TRITTY 200 Aqua
Plank 1-Strip 4V
Elm Vario authentic soft
(wood reproduction)*

HARO Laminate Floor
TRITTY200 Aqua
Gran Via 4V
Oak Sicilia White authentic matt
(wood reproduction)





HARO Laminate Floor
TRITTY 200 Aqua
Plank 1-Strip 4V
Oak Metallic Nature authentic
(wood reproduction)





*HARO Laminate Floor
TRITTY 200 Aqua
Gran Via 4V
Acacia Vario authentic soft
(wood reproduction)*



*HARO Laminate Floor
TRITTY 200 Aqua
Gran Via 4V
Oak Portland Puro authentic
(wood reproduction)*



*Try our HARO Room
Visualizer now.*

TRITTY 200 Aqua Technology and range



1

The overlay, the top layer, is specially impregnated and therefore almost as hard as diamond and is hard to beat when it comes to durability, scratch resistance and strength.

2

The decorative layer is made from a special lightfast paper that is elaborately printed and impregnated with melamine resin to ensure a high degree of naturalness and bright, brilliant colours. The decorative laminate and kraft paper are specially impregnated.

3

The dimensionally stable AquaReject coreboard is also approved for use in damp rooms in accordance with WO-1 (DIN 18534), such as domestic bathrooms or kitchens, due to the highest possible swelling resistance.

4

The multi-layer, moisture-repellent balancing laminate on the back of the floorboard balances out the tension to the overlay. It prevents the boards from warping and offers additional moisture protection.





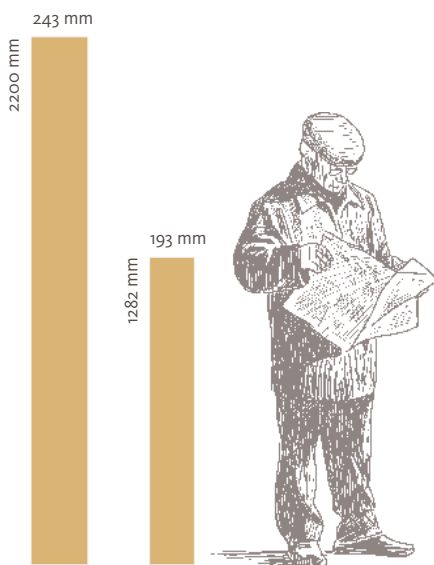









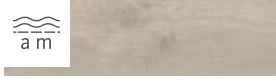





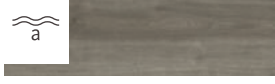

5

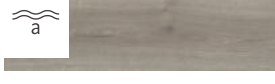
Optionally available with integrated Silent Pro luxury insulation layer or with Silent CT technology (suitable for use with underfloor heating)

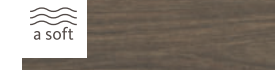
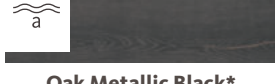

Gran Via 4V, Plank 1-Strip 4V

Gran Via 4V / Plank 1-Strip 4V

White	Grey	Nature Light	Nature Medium	Nature Dark
 Oak Eleganza Creme White* Plank 1-Strip 4V ID no. 541559 Gran Via 4V ID no. 541584	 Oak Emilia Velvet Grey* Plank 1-Strip 4V ID no. 540244 Gran Via 4V ID no. 540271	 Oak Eleganza Puro* Plank 1-Strip 4V ID no. 541558 Gran Via 4V ID no. 541583	 Elm Vario* Plank 1-Strip 4V ID no. 544784 Gran Via 4V ID no. 544814	 Oak Eleganza Smoked* Plank 1-Strip 4V ID NO. 542056 Gran Via 4V ID no. 542059
 Oak Sicilia White* Plank 1-Strip 4V ID no. 537368 Gran Via 4V ID no. 537374	 Oak Veneto Mocca* Plank 1-Strip 4V ID no. 537373 Gran Via 4V ID no. 537379	 Oak Emilia Puro* Plank 1-Strip 4V ID no. 540243 Gran Via 4V ID no. 540270	 Oak Eleganza Nature* Plank 1-Strip 4V ID no. 541557 Gran Via 4V ID no. 541582	 Oak Flavia Smoked* Plank 1-Strip 4V ID no. 544763 Gran Via 4V ID no. 544793
 Oak Contura Stone Grey* Plank 1-Strip 4V ID no. 540239 Gran Via 4V ID no. 540266	 Oak Eleganza Antique Grey* Plank 1-Strip 4V ID no. 541555 Gran Via 4V ID no. 541580	 Oak Portland Puro* Plank 1-Strip 4V ID no. 539146 Gran Via 4V ID no. 539148	 Oak Emilia Honey* Plank 1-Strip 4V ID no. 540242 Gran Via 4V ID no. 540269	 Walnut Vario* Plank 1-Strip 4V ID no. 544778 Gran Via 4V ID no. 544808
 Silver Maple Vario* Plank 1-Strip 4V ID no. 544781 Gran Via 4V ID no. 544811	 Oak Flavia Grey* Plank 1-Strip 4V ID no. 544760 Gran Via 4V ID no. 544790	 Oak Veneto Crema* Plank 1-Strip 4V ID no. 541560 Gran Via 4V ID no. 541585	 Oak Portland Nature* Plank 1-Strip 4V ID no. 540245 Gran Via 4V ID no. 540272	 Acacia Vario* Plank 1-Strip 4V ID no. 544787 Gran Via 4V ID no. 544817
	 Oak Metallic Black* Plank 1-Strip 4V ID no. 544772 Gran Via 4V ID no. 544802	 Oak Flavia Puro* Plank 1-Strip 4V ID no. 544769 Gran Via 4V ID no. 544799	 Oak Flavia Nature* Plank 1-Strip 4V ID no. 544766 Gran Via 4V ID no. 544796	
		 Oak Sicilia Puro* Plank 1-Strip 4V ID no. 537370 Gran Via 4V ID no. 537376	 Oak Sicilia Nature* Plank 1-Strip 4V ID no. 537371 Gran Via 4V ID no. 537377	
			 Oak Metallic Nature* Plank 1-Strip 4V ID no. 544775 Gran Via 4V ID no. 544805	

Level of Use:	23/33
Abrasion class:	AC6
Impact class:	IC3
Scratch resistance:	Grade 5
Electrostatic behaviour:	Antistatic class ASF2
Warranty:	25 years in residential applications, 10 years in commercial applications
Dimensions***:	Plank 1-Strip 4V: 8 x 193 x 1282 mm, with Silent Pro luxury insulation layer or Silent CT: 2 mm higher Gran Via 4V: 8 x 243 x 2200 mm, with Silent Pro luxury insulation layer or Silent CT: 2 mm higher
Indoor sound improvement with Silent CT:	60 %**
Footfall sound improvement with Silent CT:	14 dB
Indoor sound improvement with Silent Pro luxury insulation layer:	approx. 30 %**
Footfall sound improvement with Silent Pro luxury insulation layer:	18 dB

* Wood reproduction

** Measured by EPLF Impact Hammer/Walking Lady tests (compared to reference floor)

*** Thickness x Width x Length

TRITTY 100

The tough laminate floor
with the huge selection

- Particularly resistant with a thickness of 8 mm and level of use 32
- Available with Silent Pro (luxury insulation layer)
or Silent CT (the world's quietest laminate floor)
- Suitable for use with underfloor heating and cooling
- Double moisture protection due to aquaTec system

Formats



Gran Via 4V,
Plank 1-Strip 4V,
Campus 4V



HARO Laminate Floors
TRITTY 100
Gran Via 4V
Oak Flavia Nature authentic
(wood reproduction)



HARO Laminate Floor
TRITTY 100
Plank 1-Strip 4V
Oak Eleganza Creme White authentic
(wood reproduction)





*HARO Laminate Floor
TRITTY 100
Plank 1-Strip 4V
Oak Contura Smoked authentic
(wood reproduction)*



*HARO Laminate Floor
TRITTY 100
Campus 4V
Oak Flavia Grey authentic
(wood reproduction)*

HARO Laminate Floor
TRITTY100
Plank 1-Strip 4V
Walnut Vario authentic soft
(wood reproduction)



HARO Laminate Floor
TRITTY100
Gran Via 4V
Silver Maple Vario authentic soft
(wood reproduction)

Particularly
natural surface
finishes

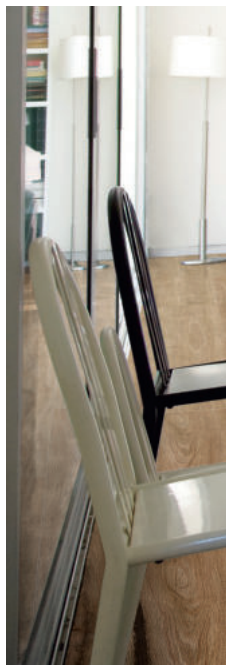



HARO Laminate Floor
TRITTY¹⁰⁰
Plank 1-Strip 4V
Oak Veneto Mocca authentic matt
(wood reproduction)

TRITTY 100

Technology and range



1

The overlay, the top layer, is specially impregnated and therefore almost as hard as diamond and is hard to beat when it comes to durability, scratch resistance and strength.

2

The decorative layer is made from a special lightfast paper that is elaborately printed and impregnated with melamine resin to ensure a high degree of naturalness and bright, brilliant colours. The decorative laminate and kraft paper are specially impregnated.

3

The special moisture-control HDF-E1 coreboard 'aquaresist' ensures maximum dimensional stability and protection from moisture.

4

The multi-layer, moisture-repellent balancing laminate on the back of the floorboard balances out the tension to the overlay. It prevents the boards from warping and offers additional moisture protection.

5

Optionally available with integrated Silent Pro luxury insulation layer or with Silent CT technology (suitable for use with underfloor heating)

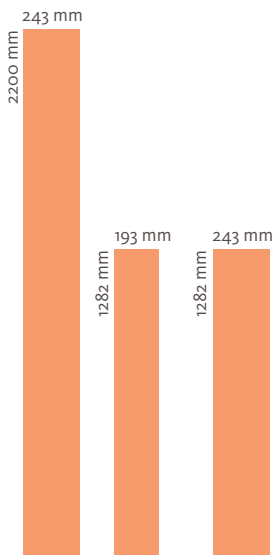















Gran Via 4V, Plank 1-Strip 4V, Campus 4V







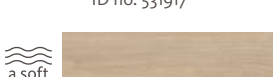
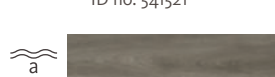
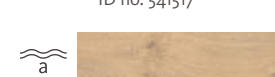
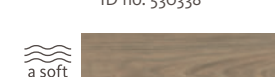
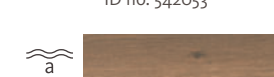
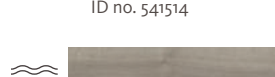
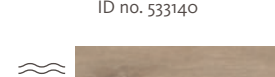
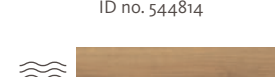
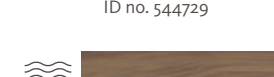
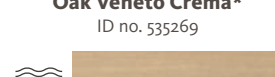
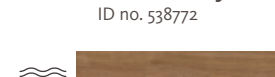
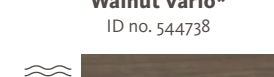
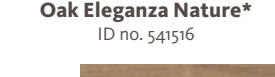
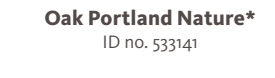









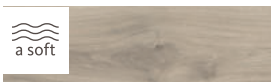





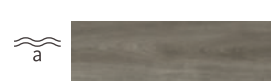

Smart advice.
Get online
product advice here!

Gran Via 4V

White	Grey	Nature Light	Nature Medium	Nature Dark
 <p>Oak Emilia White* ID no. 538765</p>	 <p>Oak Bergamo Silver Grey* ID no. 541513</p>	 <p>Oak Italica Creme* ID no. 530693</p>	 <p>Alpine Oak Nature* ID no. 526709</p>	 <p>Vintage Oak* ID no. 526712</p>
 <p>Oak Eleganza Creme White* ID no. 541518</p>	 <p>Oak Emilia Velvet Grey* ID no. 538770</p>	 <p>Oak Emilia Puro* ID no. 538769</p>	 <p>Oak Veneto Nature* ID no. 541520</p>	 <p>Oak Contura Smoked* ID no. 538773</p>
 <p>Oak Contura Stone Grey* ID no. 531917</p>	 <p>Oak Veneto Mocca* ID no. 541521</p>	 <p>Oak Eleganza Puro* ID no. 541517</p>	 <p>Oak Italica Nature* ID no. 530338</p>	 <p>Oak Eleganza Smoked* ID no. 542053</p>
 <p>Silver Maple Vario* ID no. 544741</p>	 <p>Oak Eleganza Antique Grey* ID no. 541514</p>	 <p>Oak Portland Puro* ID no. 533140</p>	 <p>Elm Vario* ID no. 544814</p>	 <p>Oak Flavia Smoked* ID no. 544729</p>
	 <p>Oak Flavia Grey* ID no. 544726</p>	 <p>Oak Veneto Crema* ID no. 535269</p>	 <p>Oak Emilia Honey* ID no. 538772</p>	 <p>Walnut Vario* ID no. 544738</p>
		 <p>Oak Flavia Puro* ID no. 544735</p>	 <p>Oak Eleganza Nature* ID no. 541516</p>	 <p>Acacia Vario* ID no. 544747</p>
			 <p>Oak Portland Nature* ID no. 533141</p>	
			 <p>Oak Flavia Nature* ID no. 544732</p>	

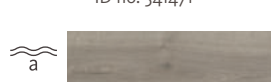
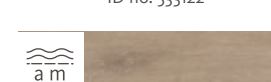
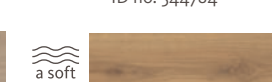
Plank 1-Strip 4V

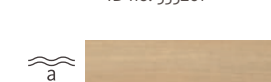
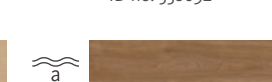
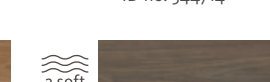
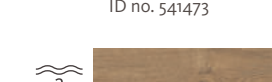
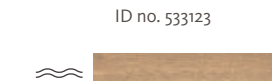
White	Grey	Nature Light	Nature Medium	Nature Dark
 <p>Oak Emilia White* ID no. 538689</p>	 <p>Oak Bergamo Silver Grey* ID no. 541470</p>	 <p>Oak Italica Creme* ID no. 538920</p>	 <p>Alpine Oak Nature* ID no. 542069</p>	 <p>Vintage Oak* ID no. 526678</p>
 <p>Oak Eleganza Creme White* ID no. 541475</p>	 <p>Oak Emilia Velvet Grey* ID no. 538695</p>	 <p>Oak Emilia Puro* ID no. 538691</p>	 <p>Oak Veneto Nature* ID no. 541478</p>	 <p>Oak Contura Smoked* ID no. 538697</p>
 <p>Oak Contura Stone Grey* ID no. 538696</p>	 <p>Oak Veneto Mocca* ID no. 541477</p>	 <p>Oak Eleganza Puro* ID no. 541474</p>	 <p>Oak Italica Nature* ID no. 530335</p>	 <p>Oak Eleganza Smoked* ID no. 542050</p>
 <p>Silver Maple Vario* ID no. 544717</p>	 <p>Oak Eleganza Antique Grey* ID no. 541471</p>	 <p>Oak Portland Puro* ID no. 533122</p>	 <p>Elm Vario* ID no. 544784</p>	 <p>Oak Flavia Smoked* ID no. 544705</p>
	 <p>Oak Flavia Grey* ID no. 544702</p>	 <p>Oak Veneto Crema* ID no. 535261</p>	 <p>Oak Emilia Honey* ID no. 538692</p>	 <p>Walnut Vario* ID no. 544714</p>
		 <p>Oak Flavia Puro* ID no. 544711</p>	 <p>Oak Eleganza Nature* ID no. 541473</p>	 <p>Acacia Vario* ID no. 544723</p>
			 <p>Oak Portland Nature* ID no. 533123</p>	
			 <p>Oak Flavia Nature* ID no. 544708</p>	

Campus 4V



Level of Use:	23/32
Abrasion class:	AC4
Impact class:	IC2
Scratch resistance:	Grade 4
Electrostatic behaviour:	Antistatic class ASF2
Warranty:	25 years in residential applications, 5 years in commercial applications
Dimensions***:	Plank 1-Strip 4V: 8 x 193 x 1282 mm / Campus 4V: 8 x 243 x 1282 mm / Gran Via 4V: 8 x 243 x 2200 mm, with Silent Pro luxury insulation layer: 2 mm higher
Indoor sound improvement with Silent CT:	approx. 30 %**
Footfall sound improvement with Silent CT:	18 dB
Indoor sound improvement with Silent Pro luxury insulation layer:	60 %**
Footfall sound improvement with Silent Pro luxury insulation layer:	14 dB

* Wood reproduction

** Measured by EPLF Impact Hammer/Walking Lady tests (compared to reference floor)

*** Thickness x Width x Length

TRITTY 90

Trendy floor design –
beautiful and durable

- With a construction height of only 7 millimetres, it is ideal for renovations
- High resistance thanks to level of use 32
- Available with Silent Pro (luxury insulation underlay) or Silent CT
the world's quietest laminate floor
- Suitable for use with underfloor heating and cooling
- Double moisture protection due to aquaTec system

Formats



Plank 1-Strip 4V

HARO Laminate Floor
TRITTY 90
Plank 1-Strip 4V
Chestnut Varese authentic soft
(wood reproduction)





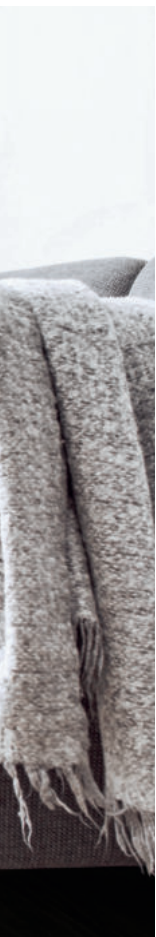

*HARO Laminate Floor
TRITTY 90
Plank 1-Strip 4V
Walnut Cesano soft matt
(wood reproduction)*



*HARO Laminate Floor
TRITTY 90
Plank 1-Strip 4V
Pine Florence soft matt
(wood reproduction)*



*HARO Laminate Floor
TRITTY 90
Plank 1-Strip 4V
Oak Bari Amber authentic
(wood reproduction)*



*Try our HARO Room
Visualizer now.*

TRITTY 90

Technology and range



1

The overlay, the top layer, is specially impregnated and therefore almost as hard as diamond and is hard to beat when it comes to durability, scratch resistance and strength.

2

The decorative layer is made from a special lightfast paper that is elaborately printed and impregnated with melamine resin to ensure a high degree of naturalness and bright, brilliant colours. The decorative laminate and kraft paper are specially impregnated.

3

The special moisture-control HDF-E1 coreboard 'aquaresist' ensures maximum dimensional stability and protection from moisture.

4

The multi-layer, moisture-repellent balancing laminate on the back of the floorboard balances out the tension to the overlay. It prevents the boards from warping and offers additional moisture protection.

5

Optionally available with integrated Silent Pro luxury insulation layer or with Silent CT technology (suitable for use with underfloor heating)

1282 mm
193 mm



Plank 1-Strip 4V



Smart advice.
Get online
product advice here!

Plank 1-Strip 4V

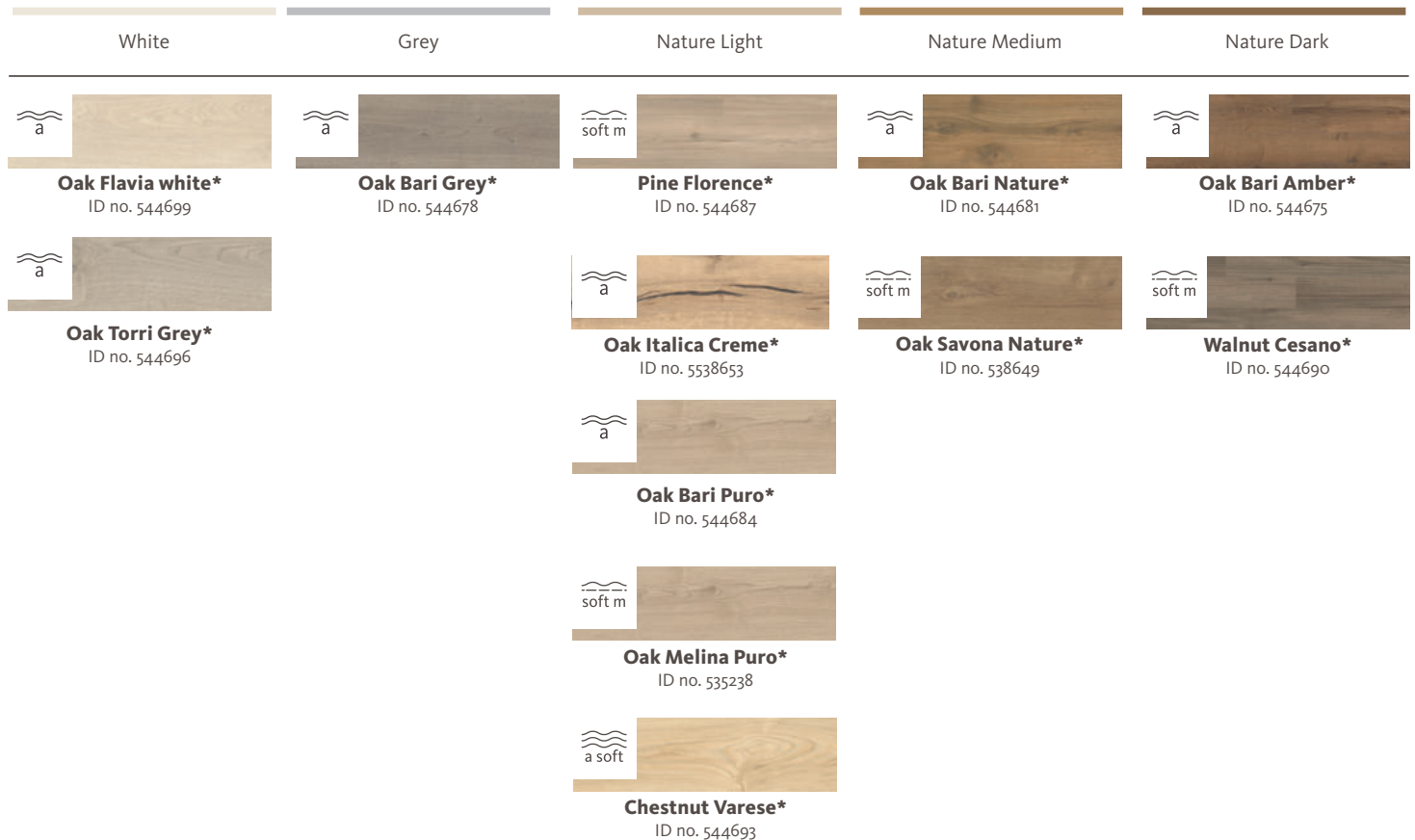

Level of Use:	23/32
Abrasion class:	AC4
Impact class:	IC2
Scratch resistance:	Grade 4
Electrostatic behaviour:	Antistatic class ASF2
Warranty:	20 years in residential applications, 5 years in commercial applications
Dimensions***:	7 x 193 x 1282 mm, with Silent Pro luxury insulation layer: 2 mm higher
Indoor sound improvement with Silent CT:	approx. 60 %**
Footfall sound improvement with Silent CT:	18 dB
Indoor sound improvement with Silent Pro luxury insulation layer:	60 %**
Footfall sound improvement with Silent Pro luxury insulation layer:	14 dB

* Wood reproduction

** Measured by EPLF Impact Hammer/Walking Lady tests (compared to reference floor)

*** Thickness x Width x Length

Special Edition NKL 31

The perfect starter floor

- With a construction height of only 7 millimetres, it is ideal for renovations
- Suitable for use with underfloor heating and cooling
- For all residential applications

Formats



Plank 1-Strip, 3-Strip, 2-Strip

HARO Laminate Floor
Special edition NKL31
Plank 1-Strip
Oak Scarpa Nature textured matt
(wood reproduction)





HARO Laminate Floor
Special edition NKL 31
2-Strip
Graphite Oak textured matt
(wood reproduction)



HARO Laminate Floor
Special edition NKL 31
Plank 1-Strip
Oak Siena Puro textured matt
(wood reproduction)



*HARO Laminate Floor
Special edition NKL 31
Plank 1-Strip
Oak Lombardia textured matt
(wood reproduction)*



*This could be your NKL 31 floor.
Test the look
with our HARO Room Visualizer!*

Special edition NKL31 Technology and range



1

The overlay, the top layer, is specially impregnated and therefore almost as hard as diamond and is hard to beat when it comes to durability, scratch resistance and strength.

2

The decorative layer is made from a special lightfast paper that is elaborately printed and impregnated with melamine resin to ensure a high degree of naturalness and bright, brilliant colours. The decorative laminate and kraft paper are specially impregnated.

3

The special moisture-control HDF-E1 coreboard 'aquaresist' ensures maximum dimensional stability and protection from moisture.

4

The multi-layer, moisture-repellent balancing laminate on the back of the floorboard balances out the tension to the overlay. It prevents the boards from warping and offers additional moisture protection.

5

Optionally available with integrated Silent Pro luxury insulation layer (suitable for use with underfloor heating)

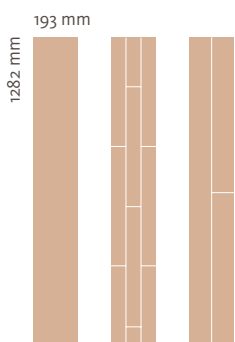













Plank 1-Strip,
3-Strip, 2-Strip



Smart advice.
Get online
product advice here!

Plank 1-Strip, 3-Strip, 2-Strip

White	Grey	Nature Light	Nature Medium	Nature Dark
 Oak Siena Velvet White* Plank 1-Strip ID no. 544655	 Graphite Oak* 2-Strip ID no. 544657	 Oak Siena Puro* Plank 1-Strip ID no. 544653	 Oak Scarpa Nature* Plank 1-Strip ID no. 544655	 Oak Scarpa Smoked* Plank 1-Strip ID no. 544669
		 Oak Olbia* Plank 1-Strip ID no. 544651	 Oak Lombardia* Plank 1-Strip ID no. 544673	 Oak Calabria* 2-Strip ID no. 544667
		 Maple* 3-Strip ID no. 544661		 Walnut* 3-Strip ID no. 544665
		 Holm Oak* 3-Strip ID no. 544659		
		 Beech* 3-Strip ID no. 544663		

Level of Use:	23/31
Abrasion class:	AC3
Impact class:	IC1
Scratch resistance:	Grade 3
Electrostatic behaviour:	Antistatic class ASF2
Warranty:	15 years in residential applications
Dimensions***:	7 x 193 x 1282 mm, with Silent Pro luxury insulation layer: 2 mm higher
Indoor sound improvement with Silent CT:	-
Footfall sound improvement with Silent CT:	-
Indoor sound improvement with Silent Pro luxury insulation layer:	approx. 30% **
Footfall sound improvement with Silent Pro luxury insulation layer:	18 dB

* Wood reproduction

** Measured by EPLF Impact Hammer/Walking Lady tests (compared to reference floor)

*** Thickness x Width x Length

Install your favourite floor virtually in your own home... now.

A new floor will transform your room. Why not take a look at your home with your favourite floor right now? Simply download the Room Visualizer app and drag the desired floor into your virtual room. Take your time and try it a few times until you feel confident with your choice. Enjoy the peace of mind of knowing you have chosen the right floor, and then relish the excitement of anticipation.

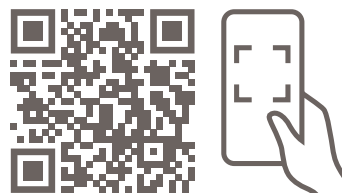

Try our HARO Room Visualizer now.



FIND STORE



PRODUCT OPTIONS



HARO PARQUET 4000 Plank 1-Strip 180 4V Oak Sauvage brushed natura...



All Favorites

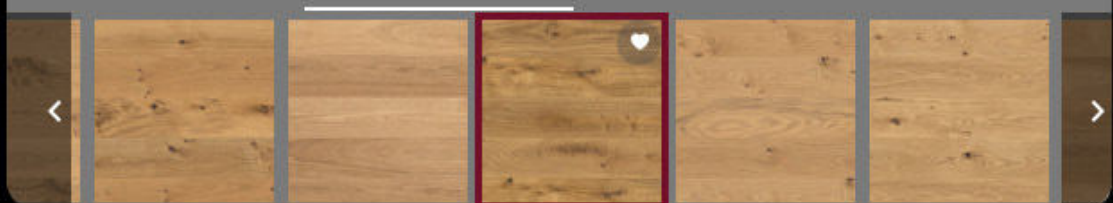

You can find detailed installation instructions on HARO.com

Top Connect – the easiest method of installation

Thanks to the innovative Top Connect installation system, you can easily and quickly install our laminate floors yourself – and remove them just as easily when you move home. No tools are necessary. Simply angle in the floorboard, push it against the previously laid board and press it down. Done! Installation is quick and your floor will be dimensionally stable and fit precisely. It can also be installed on underfloor heating and cooling systems. We always have the matching accessories for your HARO Laminate Floor. You can find out more about insulation underlays, skirtings and mouldings on page 52.

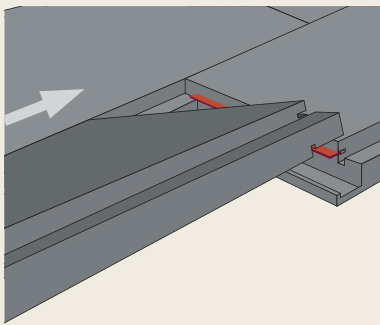

Angle in

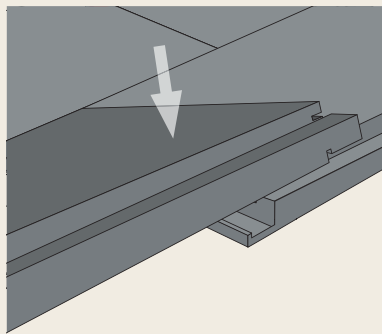

Press down

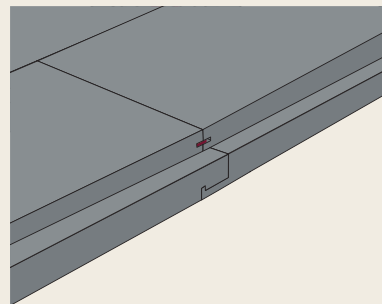

Done



Fold Down locking system



Incredibly quiet

With HARO TRITTY Silent CT, we have invented the world's quietest laminate floor – indoor sound is reduced by 60% compared to conventional laminate floors. True living comfort! This makes HARO TRITTY Silent CT the perfect choice for rooms that are used intensively for living and playing, such as living rooms or children's rooms. The Silent CT technology is available for all TRITTY series, except for the NKL 31 special edition.

Easy to clean and maintain

HARO Laminate Floors are extremely easy to care for and remain timelessly beautiful. Dry cleaning with a vacuum cleaner or a broom is all that is necessary. Simply sweep or vacuum the floor and, if necessary, wipe the floor with a damp cloth using the eco-friendly cleaning agent 'clean & green active', which is specifically designed for HARO Laminate Floors.



60% quieter
than standard
laminate
floors

HARO

**Original
Accessories**

safe

coordinated

tried & tested

HARO Accessories

Always a perfect match.

From skirtings to insulation underlays: HARO offers a wide range of matching accessories for your floor. Manufactured in the same quality and perfectly matched to the look and characteristics of your parquet floor – for a better feeling when restyling your home.

HARO Laminate Floor
TRITTY200 Aqua
Gran Via 4V
Oak Portland Puro authentic
(wood reproduction)



Guaranteed to fit: HARO Accessories

When you select HARO, you get more than just a floor. For HARO offers perfectly harmonised accessories, cleaning and care products, and replacement parts – not just for today and tomorrow, but for the entire lifetime of your floor. After all, as a fifth-generation family business, we are well aware of the importance of continuity and reliability – for the availability of our products as well as the relationship with our valued dealers and installation partners.

We always offer the right cleaning product so that you can keep your floor clean easily and gently. You will be amazed at how little of the care product you need.

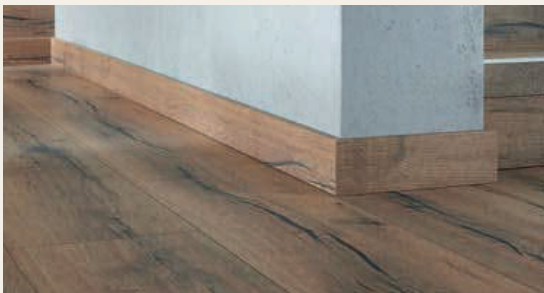

Skirtings

Matching or contrasting? Skirtings enable transitions between the floor and the wall that are visually and functionally attuned to your desired floor. Naturally, they are also available in water-resistant versions.

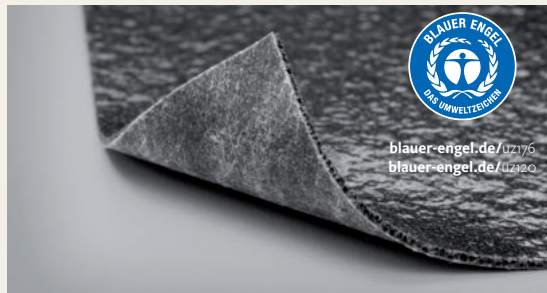

Insulation underlays

Whether with or without underfloor heating: different insulation underlays guarantee the perfect underlay for every room and every floor.



Transition mouldings

With the matching transition mouldings, you can harmoniously combine different flooring variants or even different floor coverings. Thanks to their design, the transition mouldings can also balance out different height levels.



Stair nosings

With stair nosings, the room and staircase become an aesthetic unit. This lends a particularly elegant and harmonious feel to open room concepts.



Find out more in the special catalogue and at haro.com.

HARO Laminate Floors will convince you. Guaranteed.

Every day, our employees put great expertise, experience and passion into their work. That is why we are certain that HARO's products will convince you with their outstanding quality. We emphasise this by offering warranties of 20 and 25 years, which is up to twice as long as those of other manufacturers. The fact that quality is a top priority at HARO is proven by numerous certificates from internationally recognised institutions. As a member of important industry organisations and associations, we are also committed to quality, transparency and sustainability that reach beyond our company.

Made in Germany



Our quality floors are of the highest-quality German workmanship.

Certificates



The Blue Angel certifies the environmental compatibility of our products: blauer-engel.de/uz176, blauer-engel.de/uz120

ISO Certificates



HARO's energy management is certified according to ISO 50001: 2013.



DIN EN ISO 14001: 2004 stands for active environmental management. We have been a holder of the Bavarian Quality Award since 1998, and of the PEFC seal since 2002.



Since 1995, we have been certified according to DIN EN ISO 9001:2008. This ensures consistent product quality.

CE Certificate



The CE label stands for compliance with all European safety and health directives.



HARO



Nature's ally

HARO processes and refines only high-quality, natural materials.



Tested and certified

HARO Floors are proven to create a healthy living environment and have been tried and tested millions of times.



Manufactured in Germany

HARO Floors are manufactured exclusively in Germany and installed worldwide.



Over 150 years of experience

For five generations, HARO has stood for finest craftsmanship, high quality and responsibility



Find a HARO retailer near you.

Hamberger Flooring GmbH & Co. KG
Postfach 10 03 53 | 83003 Rosenheim | Germany
T +49 8031 700-0 | F +49 8031 700-299
info@haro.com | haro.com